

TOSHIBA Transistor Silicon NPN Epitaxial Type (PCT Process)

# RN1007, RN1008, RN1009

Switching, Inverter Circuit, Interface Circuit  
And Driver Circuit Applications

- With built-in bias resistors
- Simplify circuit design
- Reduce a quantity of parts and manufacturing process
- Complementary to RN2007~RN2009

## Equivalent Circuit And Bias Resistor Values

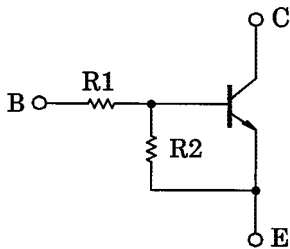

Type No.	R1 (kΩ)	R2 (kΩ)
RN1007	10	47
RN1008	22	47
RN1009	47	22

## Maximum Ratings (Ta = 25°C)

Characteristic	Symbol	Rating	Unit
Collector-base voltage	$V_{CBO}$	50	V
Collector-emitter voltage	$V_{CEO}$	50	V
Emitter-base voltage	$V_{EBO}$	6	V
		7	
		15	
Collector current	$I_C$	100	mA
Collector power dissipation	$P_C$	400	mW
Junction temperature	$T_j$	150	°C
Storage temperature range	$T_{stg}$	-55~150	°C

Unit: mm

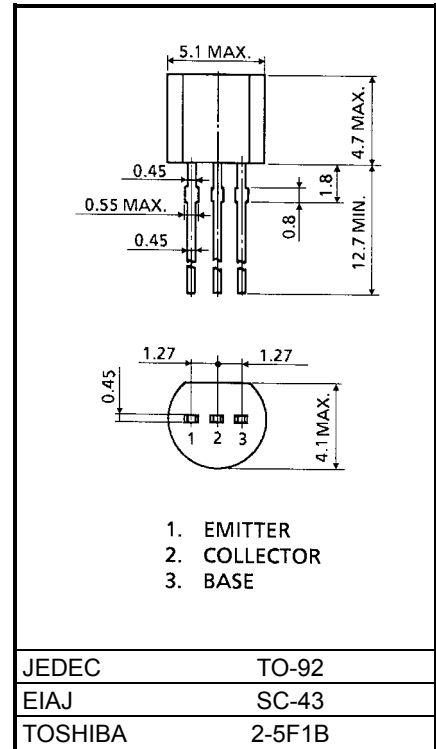

Weight: 0.21g

## Electrical Characteristics (Ta = 25°C)

Characteristic		Symbol	Test Circuit	Test Condition	Min	Typ.	Max	Unit
Collector cut-off current		$I_{CBO}$	—	$V_{CB} = 50V, I_E = 0$	—	—	100	nA
		$I_{CEO}$		$V_{CE} = 50V, I_B = 0$	—	—	500	
Emitter cut-off current	RN1007	$I_{EBO}$	—	$V_{EB} = 6V, I_C = 0$	0.081	—	0.15	mA
	RN1008			$V_{EB} = 7V, I_C = 0$	0.078	—	0.145	
	RN1009			$V_{EB} = 15V, I_C = 0$	0.167	—	0.311	
DC current gain	RN1007	$h_{FE}$	—	$V_{CE} = 5V, I_C = 10mA$	80	—	—	
	RN1008				80	—	—	
	RN1009				70	—	—	
Collector-emitter saturation voltage		$V_{CE(sat)}$	—	$I_C = 5mA, I_B = 0.25mA$	—	0.1	0.3	V
Input voltage (ON)	RN1007	$V_{I(ON)}$	—	$V_{CE} = 0.2V, I_C = 5mA$	0.7	—	1.8	V
	RN1008				1.0	—	2.6	
	RN1009				2.2	—	5.8	
Input voltage (OFF)	RN1007	$V_{I(OFF)}$	—	$V_{CE} = 5V, I_C = 0.1mA$	0.5	—	1.0	V
	RN1008				0.6	—	1.16	
	RN1009				1.5	—	2.6	
Transition frequency		$f_T$	—	$V_{CE} = 10V, I_C = 5mA$	—	250	—	MHz
Collector Output capacitance		$C_{ob}$	—	$V_{CB} = 10V, I_E = 0, f = 1MHz$	—	3	6	pF
Input resistor	RN1007	R1	—		7	10	13	kΩ
	RN1008				15.4	22	28.6	
	RN1009				32.9	47	61.1	
Resistor ratio	RN1007	R1/R2	—		0.191	0.213	0.232	—
	RN1008				0.421	0.468	0.515	
	RN1009				1.92	2.14	2.35	

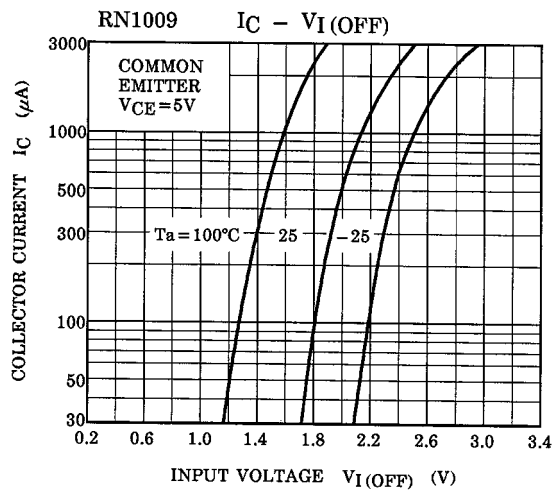
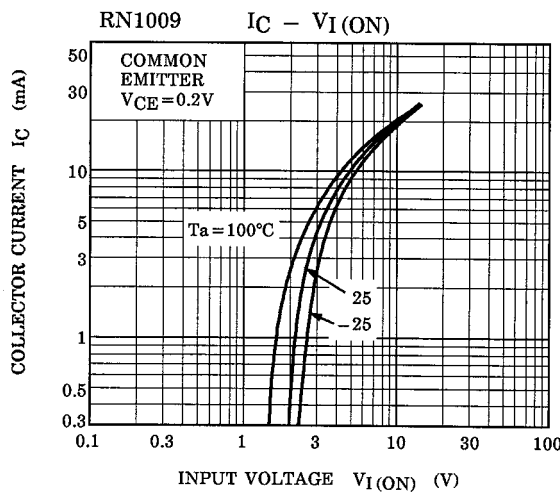
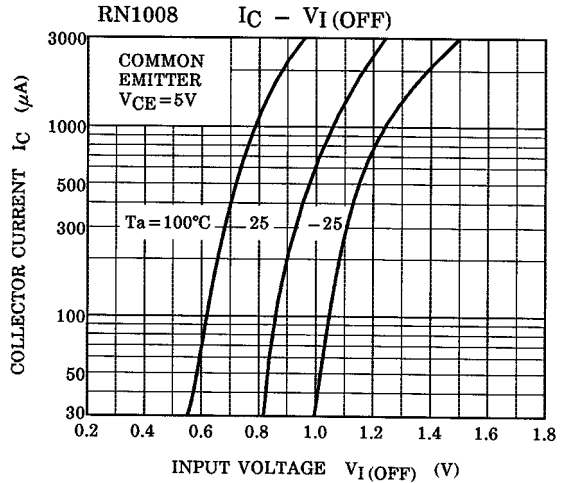
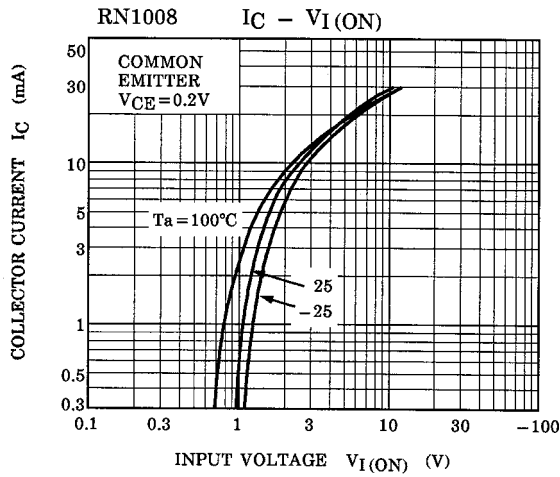
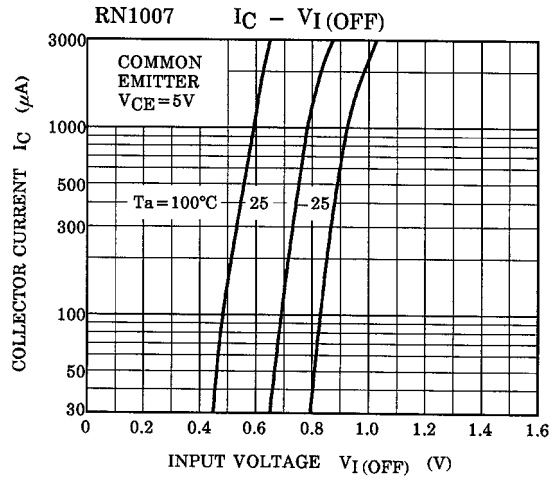
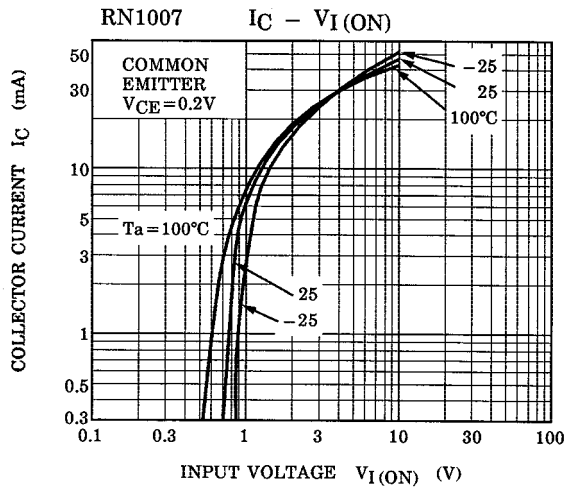

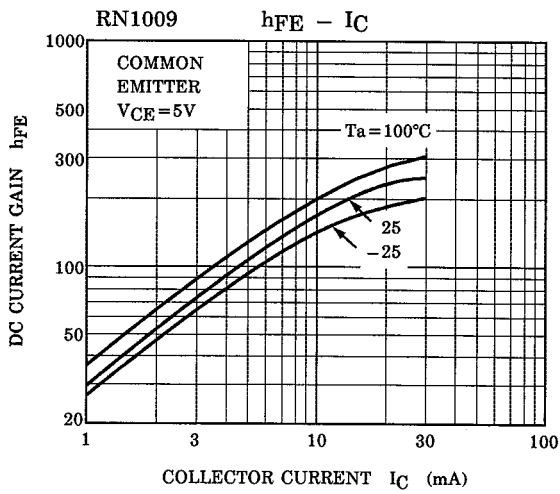
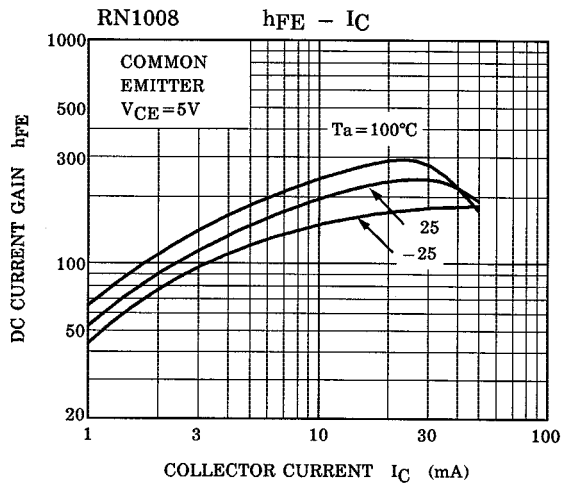
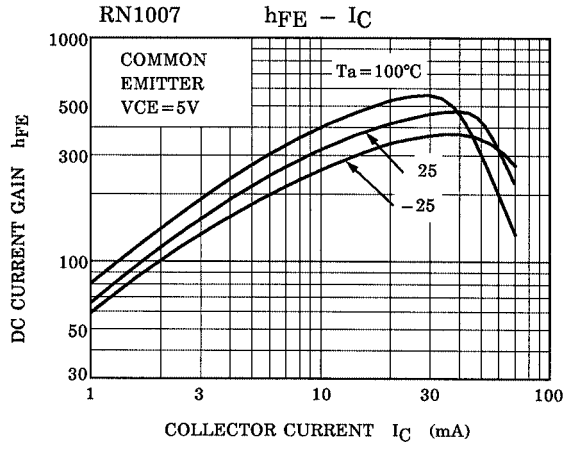

**RESTRICTIONS ON PRODUCT USE**

000707EAA

- TOSHIBA is continually working to improve the quality and reliability of its products. Nevertheless, semiconductor devices in general can malfunction or fail due to their inherent electrical sensitivity and vulnerability to physical stress. It is the responsibility of the buyer, when utilizing TOSHIBA products, to comply with the standards of safety in making a safe design for the entire system, and to avoid situations in which a malfunction or failure of such TOSHIBA products could cause loss of human life, bodily injury or damage to property.  
In developing your designs, please ensure that TOSHIBA products are used within specified operating ranges as set forth in the most recent TOSHIBA products specifications. Also, please keep in mind the precautions and conditions set forth in the "Handling Guide for Semiconductor Devices," or "TOSHIBA Semiconductor Reliability Handbook" etc..
- The TOSHIBA products listed in this document are intended for usage in general electronics applications (computer, personal equipment, office equipment, measuring equipment, industrial robotics, domestic appliances, etc.). These TOSHIBA products are neither intended nor warranted for usage in equipment that requires extraordinarily high quality and/or reliability or a malfunction or failure of which may cause loss of human life or bodily injury ("Unintended Usage"). Unintended Usage include atomic energy control instruments, airplane or spaceship instruments, transportation instruments, traffic signal instruments, combustion control instruments, medical instruments, all types of safety devices, etc.. Unintended Usage of TOSHIBA products listed in this document shall be made at the customer's own risk.
- The information contained herein is presented only as a guide for the applications of our products. No responsibility is assumed by TOSHIBA CORPORATION for any infringements of intellectual property or other rights of the third parties which may result from its use. No license is granted by implication or otherwise under any intellectual property or other rights of TOSHIBA CORPORATION or others.
- The information contained herein is subject to change without notice.